

Wireless Scanner

- MS840/MS084 -

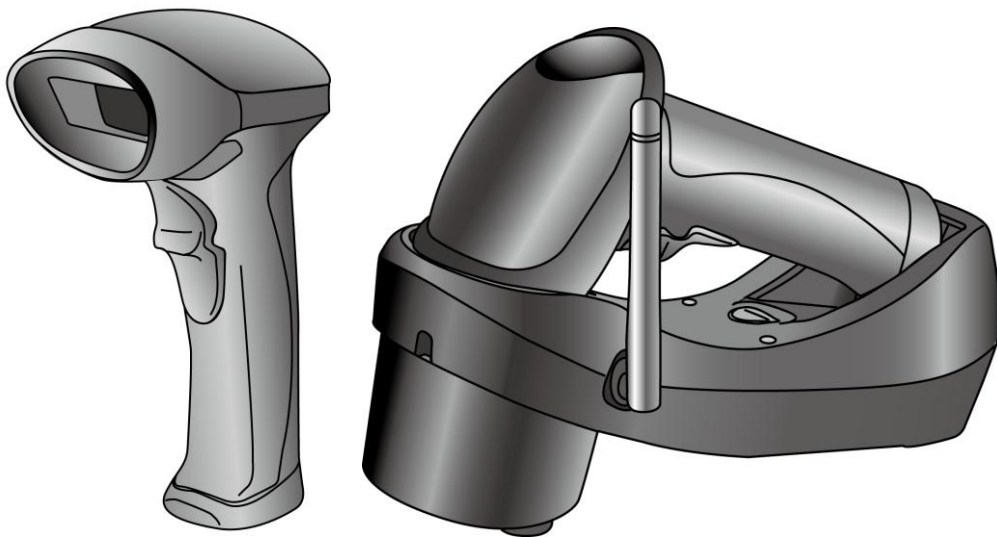

User's Manual

Version 1.1

About This Manual

This manual explains how to install, operate and maintain the MS840 Wireless Scanner.

No part of this publication may be reproduced or used in any form, or by any electrical or mechanical means, such as photocopying, recording, or information storage and retrieval systems, without permission in writing from the manufacturer. The material in this manual is subject to change without notice.

© Copyright 2011 Unitech Electronics Co., Ltd. All rights reserved.

Unitech global website address: <http://www.ute.com>

Bluetooth is a registered trademark of Bluetooth SIG.

Regulatory Compliance Statements

FCC Warning Statement

This equipment has been tested and found to comply with the limits for a Class B digital device, pursuant to part 15 of the FCC rules. These limits are designed to provide reasonable protection against harmful interference in a residential installation. This equipment generates, uses and can radiate radio frequency energy and, if not installed and used in accordance with the instructions, may cause harmful interference with radio communications. However, there is no guarantee that interference will not occur in a particular installation. If this equipment does cause harmful interference with radio or television reception, which can be determined by turning the equipment off and on, the user is encouraged to try to correct the interference by one or more of the following measures:

- Reorient or relocate the receiving antenna.
 - Increase the separation between the equipment and receiver.
 - Connect the equipment into an outlet on a circuit different from that to which the receiver is connected.
 - Consult the dealer or an experienced radio/TV technician for help.
1. This Transmitter must not be co-located or operating in conjunction with any other antenna or transmitter.
 2. This equipment complies with FCC RF radiation exposure limits set forth for an uncontrolled environment. To maintain compliance with FCC RF exposure requirements, avoid direct contact to the transmitting antenna during transmitting.
 3. Any changes or modifications (including the antennas) made to this device that are not expressly approved by the manufacturer may void the user's authority to operate the equipment.

FCC Label Statement

This device complies with part 15 of the FCC rules. Operation is subject to the following two conditions:

1. This device may not cause harmful interference, and
2. This device must accept any interference received, including interference that may cause undesired operation.

RF Radiation Exposure Statement

For body contact during operation, this phone has been tested and meets FCC RF exposure guidelines when used with an accessory that contains no metal and that positions the handset a minimum of 1.5 cm from the body. Use of other accessories may not ensure compliance with FCC RF exposure guidelines.

Canadian Compliance Statement

This Class B Digital apparatus meets all requirements of the Canadian Interference-Causing Equipment Regulations.

Cet appareil numérique de la classe B respecte les exigences du Règlement sur le matériel brouilleur du Canada.

European Conformity Statement

Declaration of Conformity with regards to the R&TTE 1999/5/EC and EMC 89/336/ EEC directives.

RoHS Statement



This device conforms to RoHS (Reduction Of Hazardous Substances) European Union regulations that set maximum concentration limits on hazardous materials used in electrical and electronic equipment.

Taiwan NCC Warning Statement

交通部電信總局低功率電波輻射性電機管理辦法 (930322)

根據交通部低功率管理辦法規定：

第十二條 經型式認證合格之低功率射頻電機，非經許可，公司、商號或使用者均不得擅自變更頻率、加大功率或變更原設計之特性及功能。

第十四條 低功率射頻電機之使用不得影響飛航安全及干擾合法通信；經發現有干擾現象時，應立即停用，並改善至無干擾時方得繼續使用。前項合法通信，指依電信法規定作業之無線電通信。

低功率射頻電機須忍受合法通信或工業、科學及醫療用電波輻射性電機設備之干擾。

減少電磁波影響，請妥適使用

Laser Information

The Unitech MS840/MS084 series is certified in the U.S. to conform to the requirements of DHHS/CDRH 21CFR Subchapter J and to the requirements of IEC 825-1. Class II and Class 2 products are not considered to be hazardous. The MS840/MS084 series contains internally a Visible Laser Diode (VLD) whose emissions do not exceed the maximum limits as set forth in the above regulations. The scanner is designed so that there is no human access to harmful laser light during normal operation, user maintenance or prescribed service operations.

The laser safety warning label required by the DHHS/IEC for the MS840/MS084 series' optional laser scanner module is located on the memory compartment cover, on the back of the unit.

CAUTION! Use of controls or adjustments or performance of procedures other than those specified herein may result in hazardous laser light. Use of optical instruments with the scanner, including binoculars, microscopes, and magnifying glasses, with will increase eye damage. This does not include eyeglasses worn by the user.

Battery Notices

The MS840 is equipped with a Lithium-Ion battery. The battery will discharge after an extended period of no use.

When the battery is discharged, recharge the unit for some 4.5 hours in order to fully charge the battery.

Note: To guarantee optimal performance, it is advised that rechargeable batteries be replaced every year, or when 500 charge/discharge cycles are achieved. It is normal that the battery balloons or expands beyond one year or the maximum of 500 cycles. Although it does not cause harm, it cannot be used again and must be disposed of according to the location's safe battery disposal procedures.

If the performance, of a Lithium-Ion battery, decrease is greater than 20% in, the battery is at the end of its life cycle. Do not continue to use, and ensure the battery is disposed of properly.

The length of time that a battery lasts depends on the battery type and how the device is used. Conserve the battery life by doing the following:

- Avoid frequent full discharges because this places additional strain on the battery. Several partial discharges with frequent recharges are better than a full discharge. Recharging a partially charged lithium-Ion battery does not cause harm because there is no memory effect.
- Keep the lithium-Ion battery cool. Avoid a hot car. For prolonged storage, keep the battery at a 40% charge level.
- Do not leave the lithium-Ion battery discharged and unused for an extended period because the battery will wear out and the longevity of the battery will be at least half of the one with frequent recharges.

Battery charge notice

It is important to consider the environment temperature when the Lithium-Ion battery pack is charged. Charging is most efficient at normal room temperature or in a slightly cooler environment. It is essential that batteries are charged within the stated range of 0°C to 40°C. Charging batteries outside of the specified range could damage the batteries and shorten their charging life cycle.

CAUTION! Do not charge batteries at a temperature lower than 0°C. This will increase the internal resistance to cause heat and make the batteries unstable and unsafe. Please use a battery temperature detecting device for a charger to ensure a safe charging temperature range.

Storage and safety notice

Although the charged Lithium-Ion battery may be left unused for several months, their capacity may be depleted due to build up of internal resistance. If this happens they will require recharging prior to use. Lithium-Ion battery may be stored at temperatures between -30°C to 70°C, however they may deplete more rapidly at higher temperatures. It is recommended to store batteries at room temperature.

Warranty

The following items covered under the Unitech Limited Warranty are free from defects during normal use:

- MS840/MS084 – 1-year limited warranty.
- Lithium-Ion battery – 6-month limited warranty.

Warranty becomes void if equipment is modified, improperly installed or used, damaged by accident or neglect, or if any parts are improperly installed or replaced by the user.

Use only the adapter supplied. Using the wrong adapter may damage the unit and will void the warranty.

Table of Contents

PREFACE

ABOUT THIS MANUAL	I
Regulatory Compliance Statements	ii
<i>FCC Warning Statement</i>	<i>ii</i>
<i>FCC Label Statement</i>	<i>ii</i>
<i>RF Radiation Exposure Statement</i>	<i>ii</i>
<i>Canadian Compliance Statement</i>	<i>ii</i>
<i>European Conformity Statement</i>	<i>iii</i>
<i>RoHS Statement</i>	<i>iii</i>
<i>Taiwan NCC Warning Statement</i>	<i>iii</i>
Laser Information	iii
Battery Notices	iv
<i>Battery charge notice</i>	<i>iv</i>
<i>Storage and safety notice</i>	<i>iv</i>
Warranty	v
CHAPTER 1	
OVERVIEW	1
Introducing the MS840/MS084	1
Package Contents	2
CHAPTER 2	
BATTERY CHARGING AND CONNECTION	5
Battery Charging via Cradle	5
Connection of a Scanner through a Cradle to a PC	6
<i>Cradle Mode (with SCM support)</i>	<i>6</i>
<i>Wall-Mount Installation of a Cradle</i>	<i>7</i>
Wireless Connection of a Scanner to a PC	10
<i>Cradle-less Mode (without SCM support)</i>	<i>10</i>
Change between Cradle Mode and Cradle-less Mode	12
Memory Buffer Setting	13
<i>Batch Mode</i>	<i>13</i>

<i>Inventory Mode</i>	13
LED / Beeper Indication for Scanner	15
<i>LED Indication for Scanner</i>	15
<i>Beeper Indication for Scanner</i>	15
LED Indication for Cradle	15
CHAPTER 3	
BARCODE SETTING	16
Barcode Menu Setting	16
Barcode Length Setting	17
Code ID Setting	17
Preamble (Prefix) and Postamble (Suffix).....	18
Predefined Labels.....	18
Quick Setup.....	19
Batch Setup.....	19
Scanner Configuration Manager Software	21
CHAPTER 4	
OUTPUT DATA EDITING	22
Programming	23
<i>Programming Sequence</i>	23
<i>Preparation</i>	23
<i>Programming Sheet</i>	24
<i>Parameter Entry</i>	24
Qualifier	25
<i>Input ID</i>	25
<i>Length</i>	25
<i>Match</i>	26
Modifier	26
<i>A-String</i>	26
<i>O-String</i>	27
Examples	27
<i>Example 1</i>	27
<i>Example 2</i>	27
Advanced Features	27

APPENDIX A	
QUICK SETUP SHEET	30
APPENDIX B	
FUNCTION CODES	31
Function Codes for PC.....	31
Function Codes for IBM Terminals.....	33
APPENDIX C	
SETUP MENU.....	34
APPENDIX D	
FULL ASCII CHART	43
APPENDIX E	
BARCODE TEST CHART	47
APPENDIX F	
WORLDWIDE SUPPORT	48

Overview

Introducing the MS840/MS084

First of all, thank you for choosing Unitech's products. This scanner has capability of precise barcode scanning, reconnecting automatically after off-line in a long transmitting distance. It not only provides convenient and high efficient performance but also is well featured with wireless technology.

The cradle (optional) is provided with a charger and a wireless dongle together. The scanner has a prolonged battery life, being thus able to work continuously for 10 hours while scanning a barcode every 3 seconds in 100 meters of long-range communication.

You can accelerate productivity, lower cost of ownership, and even enjoy the delight of move-around freedom. The device is the best scanning partner you can trust. Thank you for choosing Unitech product.

Features -

- ✓ Extremely low power consumption
- ✓ Firmware upgradeable
- ✓ Supports most popular barcode symbologies, including GS1-128 (EAN-128), GS1 DataBar (RSS), etc.
- ✓ Supports 2 scan profiles, Cradle Mode and Cradle-less mode
- ✓ User feedback via LED indicator and beeper
- ✓ Beeping tone and duration programmable for Good Read
- ✓ Up to 3 scanners connected to one base
- ✓ Up to 4KB of memory buffer for reading when scanner out of range
- ✓ Capable of transmitting scanned data, emulating a serial cable (Cradle Mode) or as keyboard input (Cradle-less Mode), to a laptop PC or PDA with wireless technology
- ✓ Parameters programmable, including data output format, editing format, symbologies, etc.
- ✓ Over 10 hours of operation time





Application -

- ✓ Warehouse
- ✓ Pharmacies
- ✓ Logistics
- ✓ Retailers
- ✓ Point of sale (POS)
- ✓ Inventory Management
- ✓ Distribution & Transportation

Package Contents

Please make sure the following contents are in the MS840 package box. If something is missing or damaged, please contact your Unitech representative.

Scanner Only package

			
Wireless laser scanner	Power adapter (1010-601959G)	User's manual CD	Quickly reference guide

Scanner and cradle package

			
Wireless laser scanner	Power adapter (1010-900008G)	User's manual CD	Quickly reference guide
			
Cradle (5000-900007G)	USB Cable (1550-900040G) (Optional)	PS2 Cable (1550-900041G) (Optional)	RS232 Cable (1550-900042G) (Optional)

Note:

1. The items included in the package may be different, depending on your order. Save the box and packaging material for future use in case you need to store or ship the scanner.
2. When you receive and unpack the package at first time, if any item above is lost, please contact the dealer you bought from, immediately.
3. Environment temperature for charging should be between 0°C - 40°C.
4. Up to 3 scanner devices work with only 1 host PC through 1 cradle or wireless receiver.
5. The scanner's default power off (idle mode) time is 1 min.
6. When you use the scanner for the first time, the scanner must be charged continuously for some 4.5 hours.

[Scanner Body Aspect]

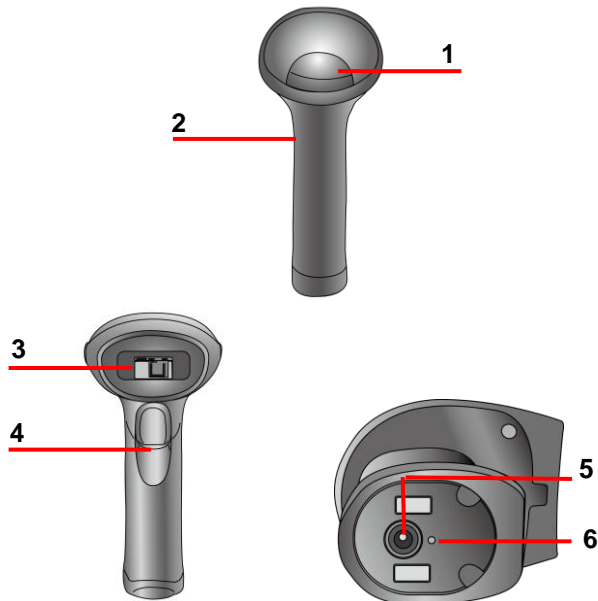

1	LED indicator	2	Scanner Grip
3	Laser Exit Window	4	Trigger
5	Scanner Contact Points for Charge	6	Reset Pinhole

[Cradle Aspect]

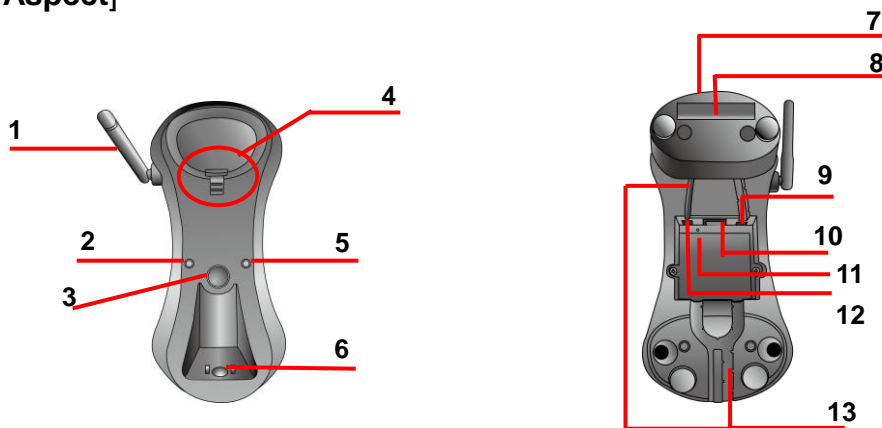

1	Antenna	2	Communication Status LED	3	Page Button
4	Wedge <small>Note 1</small>	5	Power LED	6	Cradle Contact Points for Charge
7	Cradle Foot <small>Note 2</small>	8	Cradle address barcode	9	Interface Switch <small>Note 3</small>
10	USB/RS232/PS2 Socket	11	Reset Pinhole	12	DC Power Socket (5V)
13	Guidance Groove <small>Note 4</small>				

Note:

1. If you remove the wedge and flip it upside down, it acts as a clip to hold up the scanner when the base is mounted to the wall.
2. The cradle foot serves for table mount when being fixed to the upper portion adjacent to the antenna; the cradle foot serves for wall mount when being fixed to the lower portion on the guidance grooves.
3. When using RS232 or PS2 cable the interface switch should be to the left side (default) The USB cable can support HID (default) or COM port when switch is set to right.
Before changing the switch;
 Disconnect power from cradle,
 Disconnct USB cable from cradle
 Set the interface switch
 Connect USB Cable to cradle
 Connect power to cradle

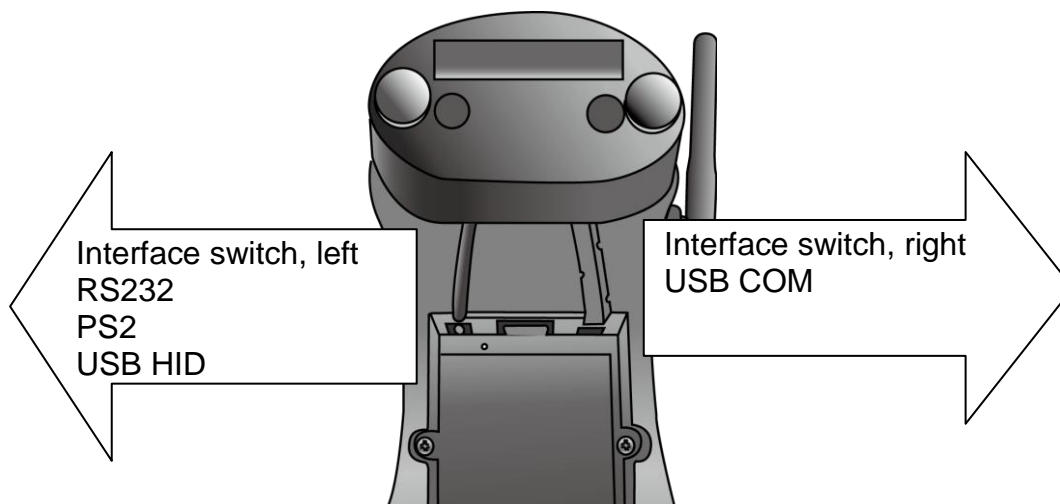

Operation in USB COM requires additional driver which is available at

<http://www.ute.com>.

In case the USB cable is been used, the cradle will receive power via USB cable. In order to charge the scanner it is mandatory to connect power supply to cradle

4. The guidance groove is designed for arrangement of the power cord and the communication cable (USB/RS232/PS2).

Chapter 2

Battery Charging and Connection

Cradle Mode, Battery Charging

The battery is in advance loaded into the compartment of the scanner and may not be fully charged before shipment. When you receive the package and use the MS840 for the first time, you will need to fully charge the battery.

Note: It takes approximately 4.5 hours to fully charge the battery.

To charge the scanner with a cradle, follow the instructions below:

1. Plug the adapter cable into the power socket on the bottom of cradle.

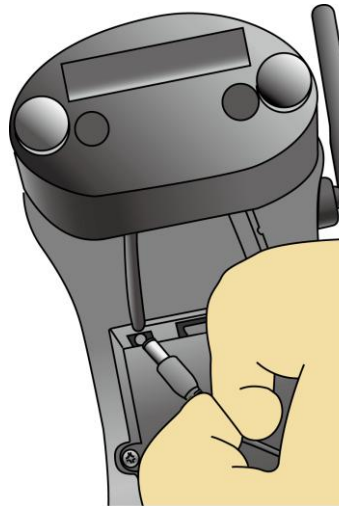

2. Plug the AC adapter cord into an electrical outlet.

Now, check whether the power LED on the cradle is bright in solid green and the communication status LED on the cradle is bright in solid blue.

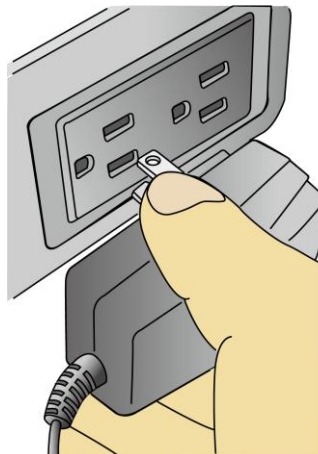

3. Place the scanner in the cradle. The scanner LED will be red to indicate charging. When the scanner is charged, the LED will turn off.

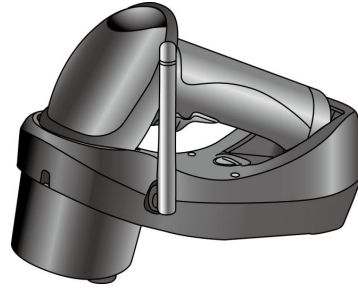

Cradle Mode, Connection

Cradle Mode (with SCM support)

In order to establish a proper connection between your computer and a scanner through a cradle, we suggest that you follow these step-by-step instructions:

1. Ensure the cradle powered, check the Power LED.
2. Turn on your computer.
3. Connect the cradle to the USB, RS232, or PS2 port of your computer respectively with a USB cable, RS232 cable, or PS2 cable.
USB cable will operate as HID device (keyboard)
4. Determine that the power LED on the cradle is bright in solid green and the communication status LED on the cradle is bright in solid blue.
5. By default, the MS840 operates in cradle mode. Thus, by using at most 3 scanners, scan the Cradle Address barcode on the bottom side of the cradle.

The Cradle Address barcode is on the bottom side of the cradle.

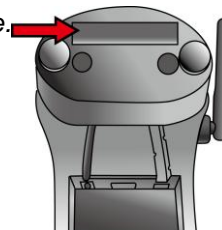

6. The scanner LED should turn off and beep shortly one time with a high tone and the communication status LED on the cradle should flash in blue.
7. The Pager button can be used to verify correct connection of scanner and cradle

Wall-Mount Installation of a Cradle

Before mounting the cradle onto the wall, read the instruction made below.

Mounting Kit (Optional article 4070-900011G)

If you want to mount the MS840 cradle onto the wall, an iron plate, two screws, and two plastic conical anchors are required.

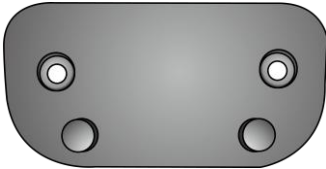

Iron Plate



2 Screws

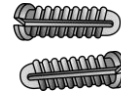

2 Plastic Conical Anchors

Before mounting the cradle onto the wall, prepare a screwdriver and read the step-by-step instructions made below.

Follow the steps below to mount the cradle onto the wall.

Step 1: Loose and remove 2 screws from the stand of cradle by using a screwdriver. Then, remove the stand from the cradle.

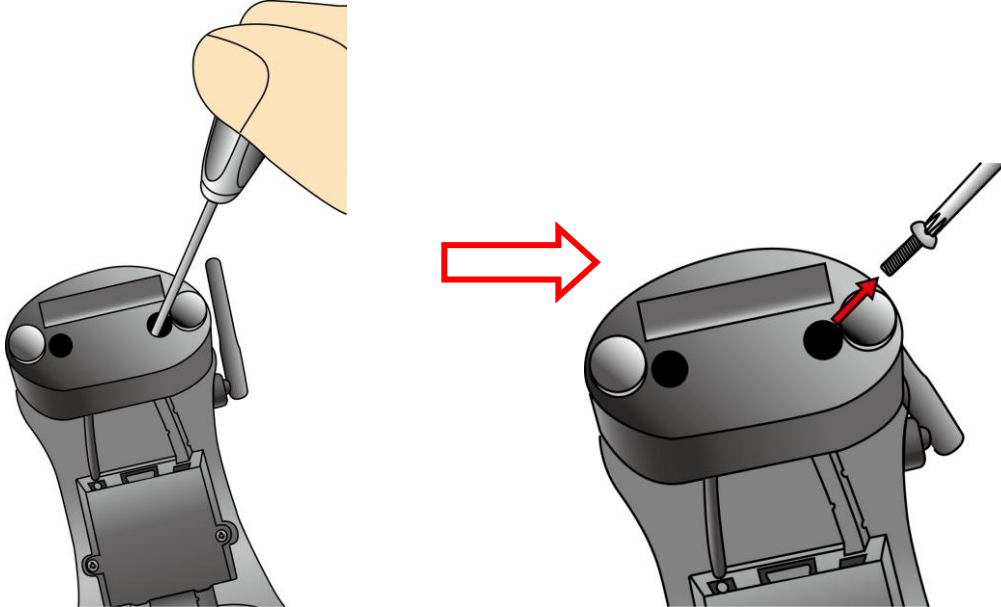

Step 2: Move the stand of cradle to the lower portion of the cradle from the upper portion adjacent to the antenna. Then, secure the stand to the cradle with 2 screws by using the screwdriver.

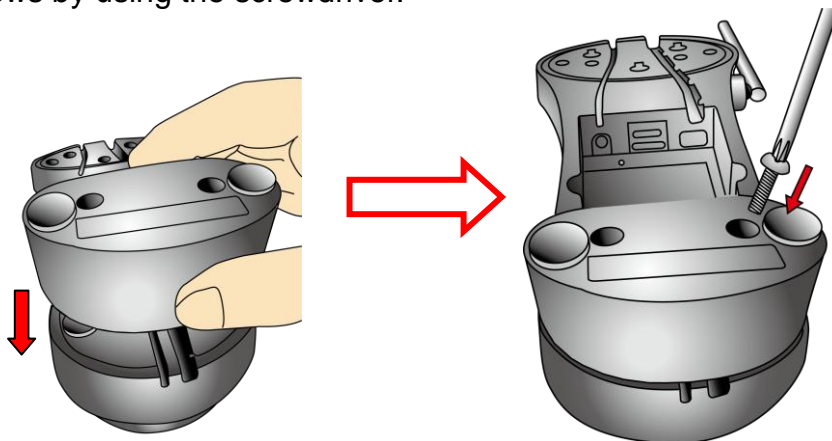

Step 3: Push up and shift out the wedge and then inversely insert the wedge. Note that the protruding portion is upward.

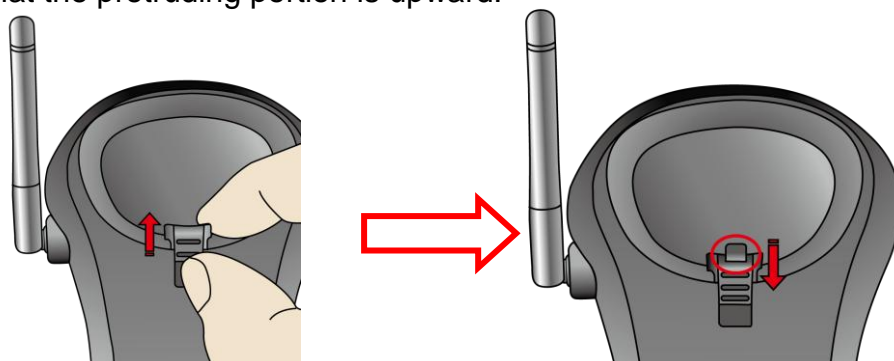

Step 4: Place the iron plate against the wall, and mark the 2 screw hole locations with a pen or pencil. Drill the screw locations somewhat deep. Insert 2 plastic conical anchors into the screw holes. Attach and secure the plate to the wall with the 2 screws.

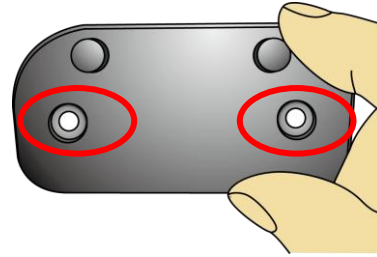

Step 5: Align the two holes on the bottom surface of the cradle respectively with the two short pillars of the iron plate for insertion of the pillars into the holes. Then, push the cradle downwards to wedge the pillars into the guidance groove.

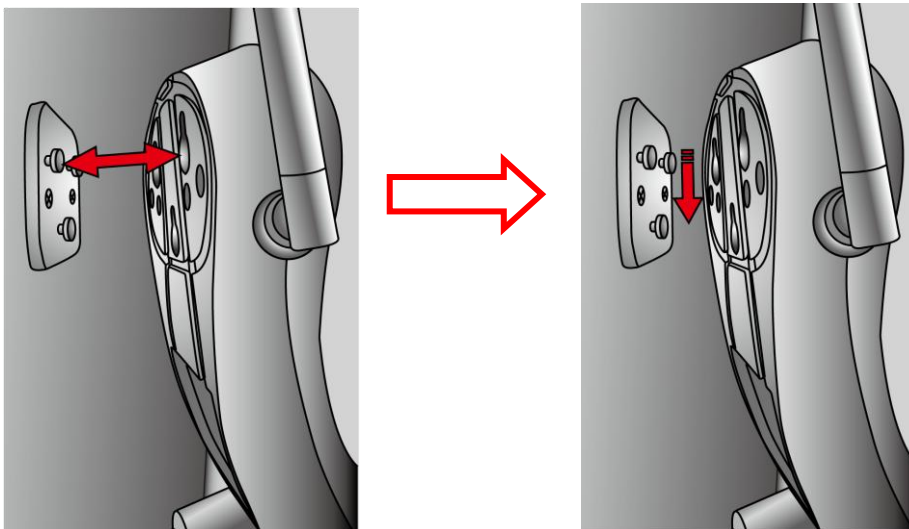

Step 6: The cradle wall-mount installation is completed, as shown in the figure below.



Cradle-less, Battery Charging

To charge the scanner without a cradle, follow the instructions below:

1. Plug the adapter cable into the power socket of the foot of scanner.

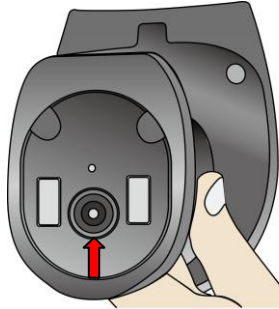

2. Plug the AC adapter cord into an electrical outlet.

Now, check whether the scanner LED will be bright in solid red during charging.

When the charging is done, the scanner LED will turn off.

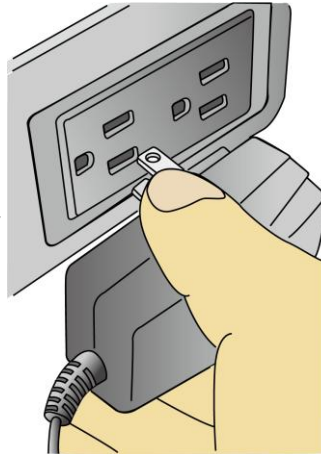

Cradle-less, Connection

Cradle-less Mode (without SCM support)

MS840 can connect directly to a Host with proper supported wireless technology. In order to establish a proper connection between your Host with wireless technology and the scanner, we suggest that you follow these step-by-step instructions:

1. Turn on your Host.
2. Change the default cradle-mode to the cradle-less mode by scanning the Cradle-less Mode barcode.



















Cradle-less Mode

3. When the change is successful, the LED indicator of scanner flashes in blue.
4. Make your Host with wireless technology search for the MS840 scanner. When your Host locates a "HID SCANNER", select it.
5. The Host should now present a pairing pin and you will be requested to input the pin code at the Scanner. For inputting the pin code, scan the "Link Keys" barcode below:



Link Keys

6. At this step, referring to the barcode table below, scan the pin code one after another you got from your PC; for example, if you get the pin code “241657”, then scan the barcodes “2” – “4” – “1” – “6” – “5” – “7” listed in the table in the order.

 0	 8
 1	 9
 2	 A
 3	 B
 4	 C
 5	 D
 6	 E
 7	 F

7. After you finish in scanning the pin code, scan the barcode as shown below:



CR(\$M)

8. When the pairing is successful, the scanner LED is off and has a short beep. The scanner will operate as HID (keyboard) towards host.

Note: Scanning the DLE(\$P) will erase the previous entered link keys.



DLE(\$P)

Change between Cradle Mode and Cradle-less Mode

You may make the scanner change between cradle mode and cradle-less mode. For example, if your scanner operates currently in cradle-less mode and you want to change the existing mode of the scanner to cradle mode, then scan the Cradle Mode barcode as shown below:



Cradle Mode

To determine whether your scanner mode is successfully changed, press the Page button on the cradle; your scanner will have 2 short beeps when you press the Page button.

For example, if your scanner operates currently in cradle mode and you want to change the existing mode of the scanner to cradle-less mode, then scan the Cradle-less Mode barcode as shown below:



Cradle-less Mode

Whenever the scanner enters cradle-less mode, you must pair the scanner with your PC following step 3 through step 8 at the section called "***Cradle-less Mode (without SCM Support)***".

Note: When you successfully connected in Cradle and/or Crade-less, both addresses are memorized in the scanner. To completely disconnect the scanner;

- 1.Scan the Cradle Mode barcode, scan the Delete Address barcode,
- 2.Scan the Cradle-less Mode barcode, scan the Delete Address barcode



Delete Address

Memory Buffer Setting

The collected data can be sent back to a host computer one by one via the WPAN connection as the scanner is set to the Batch Mode, or can be stored in the flash memory of the scanner being set to the Inventory Mode.

By default, the Batch Mode is enabled for use when the scanner is out of range. Upon reading a barcode successfully within range, the scanner responds with one short beep (high tone) and its LED indicator becomes solid green and goes off quickly. However, the host computer may not receive the data immediately if getting out of range. With the 4 KB transmit buffer, the scanner can ignore the transmission status and keep on reading barcodes until the buffer is full.

When the Batch Mode is enabled and the scanner is out of range, the scanner will respond with two short beeps, high-low tone, upon reading a barcode successfully. When the memory buffer is full, the scanner will respond with one long beep (low tone) and its LED indicator will become solid red and go off quickly. You are advised to get back to range.

MS840 features 2 memory mode settings: Batch Mode and Inventory Mode

Note: The 4 KB of memory buffer in the scanner can hold as many as 256 scans based on EAN-13 barcodes. Data will be cleared out once the scanner is not powered!

Batch Mode

Batch Mode is the default setting. To set the scanner to the Batch Mode, scan the following barcodes in the order:



In the Batch Mode, once you scan a barcode by using a scanner wirelessly connecting to the cradle (Cradle Mode) or a host PC (Cradle-less Mode) in a specified range, the scanner sends out the data. When the scanner is out of range of the cradle or the host and keeps trying to re-connect, the scanner will keep the data in its memory buffer until the buffer is full; when the scanner is again in range of the cradle or the host, the scanner will send out the data that it has in the memory buffer. When the buffer is full and the scanner is out of range, the scanner will respond with one long beep (low tone) and its LED indicator will become solid red and go off quickly. You are advised to get back to range.

Inventory Mode

Inventory Mode is the mode in which the scanner keeps the scanned data in its memory buffer but not sent out the data on the host automatically; you should scan Read Buffer barcode to order the scanner sent out the memorized data to the Host. To set the scanner to the Inventory Mode, scan the following barcodes in the order:



Bear in mind the fact that the scanner operating in the inventory mode does not sent out the scanned data automatically but keeps the data in its memory buffer. If you want to make the scanner output the data it scanned before, please scan the Read Buffer barcode as shown below:



Note: After scanning the Read Buffer barcode, the data is sent and deleted from the scanner's memory buffer.

If you do not output the barcode data, the barcode data is always kept in the memory buffer. To erase the data from the scanner's memory buffer, scan the following barcodes in the order.

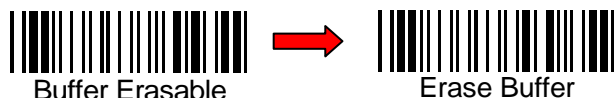

If you are out of range of the cradle or the host PC when reading out the scanned data, the scanner will keep the data in its memory buffer until the buffer is full; only when the scanner is within the specified range of the cradle or the host, and you scan the Read Buffer barcode the data will be sent.

When the buffer is disabled and the scanner is out of range, the scanner will respond with one long beep (low tone) and its LED indicator will become solid red and go off quickly. You are advised to get back to range.

Connecting Multiple Scanner

Up to 3 scanners can be connected to 1 cradle. When data is scanned (at the same time) the cradle will sent the data from one scanner and then the date of the other scanner. Different Prefix/Suffix per scanner will allow which scanner has sent the data

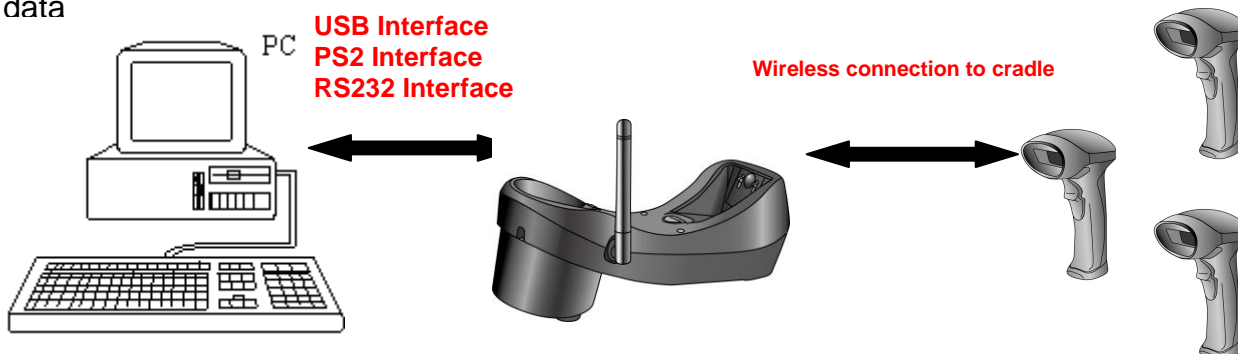

If multiple scanner are connected to Host, in cradle-less mode, the data at will/can become mixed up (simultaneous scan)

LED / Beeper Indication for Scanner

LED Indication for Scanner

The LED lights on the MS840 scanner turn on to indicate the status of the battery, a successful read of a barcode, or the status of the wireless connection.

MS840 Lights: The status LED turns green, blue, or red to indicate the status of the battery and scanning.

LED Light State	What it means
Red LED flashes per 5 seconds	Low battery power
Red LED on	1. Barcode reading when the trigger is pressed 2. Battery charging when the scanner is set on the cradle
Green LED flashes	Successful barcode reading
Blue LED fast blinks and then turns off	Successful pairing/connection/reconnection (Cradle mode)
Blue LED slow blinks	Disconnect (out of range)
Green LED blinks	Entering barcode setting mode
Green LED on	1. Exiting barcode setting mode 2. Battery charging completion
Green and blue LEDs blink	Pin code setting (waiting to enter a pin code)

Beeper Indication for Scanner

The MS840 uses beeps to give you audio feedback when it performs some functions. For example, you hear a beep each time you scan a valid barcode.

Beep Sequence	What it means
One short beep with a Hi tone	1. Successful barcode reading 2. Pin code setting (waiting to enter a pin code)
One beep with a Hi tone	Successful pairing/connection/reconnection (Cradle mode)
3 Hi-Low alarms	Disconnect (out of range)
One long beep with a Hi tone	Entering barcode setting mode
One short beep with a Hi-Low tone	Exiting barcode setting mode
2 short beeps with a Hi tone	Page calling

LED Indication for Cradle

The LED lights on the MS840 cradle turn on to indicate the status of the power and wireless connection.

LED Light State	What it means
Blue LED blink	Connection
Blue LED on	Disconnection
Green LED on	Power on
Green LED off	Power off

Barcode Setting

The scanner interface can be configured to fit the user's specific application. All configuration parameters are stored in a non-volatile memory, which is retained even if power is lost.

Barcode Menu Setting

The setup menu in **Appendix D** contains eight groups:

- * Group 1: Device selection.
- * Group 2: Beep and delay.
- * Group 3: Keyboard and Wand Emulation.
- * Group 4: RS-232 Settings
- * Group 5: Scanner port.
- * Group 6: Magnetic Reader
- * Group 7: Code 39, I 2 of 5, S 2 of 5 and Code 32.
- * Group 8: Code 128, Code 93, Code 11, Codabar, and MSI.
- * Group 9: UPC/EAN, and Delta Distance Code.
- * Group 10: Data Editing.
- * Group 11: Dump setup.

Setup Procedures

For most parameters, proceed the following steps for the setting:

1. Locate a group that contains the parameter to be changed.
2. Scan the "**Enter Group #**" label to enter setup mode. The green LED on the scanner will flash to indicate that setup is in progress.
3. Scan the label (**on right hand side**) representing the parameter to be changed, such as **B1** label.
4. Scan the labels (**number**) representing the desired parameter value; for example, for 05, scan "**0**" and "**5**" labels.
5. Repeat steps 3 and 4, if necessary, to change the parameters in the same group.
6. Scan "**Exit**" label to end the group setup. The scanner will make two beeps to end the setup.

Barcode Length Setting

The following example illustrates how to set Code 39 with a minimum length of 5 and a maximum length of 20.

- * Scan “Enter Group 7”.
- * Scan “F1” to select Code 39.
- * Scan “MIN LENGTH” to enter minimum length setting.
- * Scan “0” and “5” to select length 5.
- * Scan “MIN LENGTH” to end minimum length setting.
- * Scan “MAX LENGTH” to enter maximum length setting.
- * Scan “2” and “0” to select length 20.
- * Scan “MAX LENGTH” to end maximum length setting.
- * Scan “Exit” to end setup.

Code ID Setting

Each barcode symbology supported by the scanner has a default ID character defined below. If you don’t know what the label that you’re scanning is, you may use this feature to identify.

Symbology	Pre-Defined
UPC-A	A
UPC-E	E
EAN-13	F
EAN-8	FF
I 2 of 5	I
S 2 of 5	H
Code 39	M
Codabar	N
Code 93	L
Code 128	K
UCC/EAN128	JC1
MSI	O
Code 32	T
Delta Code	D
Plessey Code	P
Label Code IV,V	B
China Postal Code	C

Those ID characters can be redefined through setup menu. The following example shows how to set Code 93 with ID 'O' and Code 128 without ID:

- * Scan "Enter Group 5".
- * Scan "D2" to select Code ID.
- * Scan "1" for "Enable".
- * Scan "D3" to define IDs.
- * Scan "0" and "9" for selecting Code 93.
- * Scan "O" from Full ASCII Table for new ID.
- * Scan "0" and "8" to select Code 128.
- * Scan "NULL" character from Full ASCII Table for none ID.
- * Scan "Exit" to end setup.

Preamble (Prefix) and Postamble (Suffix)

Regarding Preamble, the scanner adds the start of text characters before the input data; regarding Postamble, the scanner adds the end of text characters after the input data. The following description is an example that sets 'STX' as preamble and 'ETX' as postamble.

- * Scan "Enter Group 5".
- * Scan "PP" to start preamble setting.
- * Scan 'STX' character from Full ASCII Table.
- * Scan "PP" to end preamble setting.
- * Scan "OO" to start postamble setting.
- * Scan 'ETX' from Full ASCII Table.
- * Scan "OO" to end postamble setting.
- * Scan "Exit".

Predefined Labels

The scanner provides three special labels encoded as "/FY", "/FZ", and "/F-" in Code 39 format. The output from these labels can be defined through the setup menu. The definition of the labels share the same space with "Edit Formula definition" (See "Output Data Editing"), so you can only use one of the functions.



Here is an example indicating how to define the output of "Label 0" as "START", "Label 1" as "ACCEPT", and "Label 2" as "END".

- * Scan "Enter Group 3"
- * Scan "B7"
- * Scan "0" to define "Label 0"
- * Scan "S", "T", "A", "R" and "T" from Full ASCII chart
- * Scan "B7" to end "Label 0"
- * Scan "1" to define "Label 1"
- * Scan "A", "C", "C", "E", "P" and "T" from FULL ASCII chart
- * Scan "B7" to end "Label 1"
- * Scan "2" to define "Label 2"
- * Scan "E", "N" and "D" from Full ASCII chart

- * Scan "B7" to end "Label 2"
- * Scan "Exit" to quit setup

After programming, scanning "Label 0", "Label 1", and "Label 2" listed above will have the output of "START", "ACCEPT", and "END", respectively. The characters defined in these labels can be ASCII characters or Function keys.

To eliminate the definition of "Label 1", do the following scan:

- * Scan "Enter Group 3"
- * Scan "B7"
- * Scan "1" to choose "Label 1"
- * Scan "B7" to end
- * Scan "Exit" to exit setup

There is only total 24 characters space available for defining these three labels. If one of the labels has been defined for the output with 24 characters, the other two labels cannot be defined further.

Quick Setup

Appendix A has a quick setup chart, which gives you one-label-for-one-function convenience to set up the scanner. To set up the scanner, locate the label with the function you want and scan that label.

Batch Setup

If you need to configure more than one scanner, you may duplicate the settings of the scanner (master) to the others. You can do this by producing a set of custom setup labels derived from the master scanner, and by scanning these labels configuring the other scanners.

The following label is called "Dump Settings" label. Before you scan the label, please open a text editor application (such as Notepad, Word, etc.). Scan the following label and the settings of the scanner will dump to the screen as one or several ASCII string(s). Use a barcode printing software, select Code 39 symbology, and use the string(s) to generate barcode labels. You use this batch setup labels to duplicate setting to the other scanners.



Dump Settings

If you have settings as follows:

- * Device Type is "Keybaordless Wedge".
- * Do not send the check digit of UPC-A and EAN-13.
- * Define Preamble as "<F1>".
- * Define Postamble as "<Tab>".
- * Define Label 0 as "START".

When dumping settings on a PC/AT, you have the following strings:

```
...I800C06D51DJ8  
08080A007C005354  
415254.
```

Print into Code 39 bar code labels:



...I800C06D51DJ8



08080A007C005354



415254.

By scanning the labels from top to bottom sequentially, you may duplicate the rest of scanners with the same settings.

The following issues should be observed:

- The sequence of the strings that the scanner dumped is important. You have to print the bar code labels and scan them in the same sequence as the one that the scanner dumped.
- When you scan the batch setup labels to configure a scanner, the previous settings on that scanner are reset to default and then replaced by the settings contained in the batch labels.
- Only the settings that are different from the default values will be dumped. So the number of labels produced depends on how many settings being changed compare to the factory default setting.
- The settings can be dumped to a PC or terminal only if that PC or terminal matches the type defined by Device Type of the scanner. The previous example of “Keyboardless Wedge” as Device Type is equivalent to a PC/AT interface, so you cannot dump that settings to a system which dose not support a PC/AT keyboard interface.

The following label let you dump the settings to a PC/AT regardless what kind of device has been chosen on the scanner.



Dump Settings On PC/AT

- You can adjust the length of the dumped strings by combining multiple strings into one or breaking one string into multiple strings. The following strings have the same effect as the dumped string listed above:

**...I800C06D51DJ8080
80A007C005354415254.**

You cannot delete any character from or add any character into the strings and the first three characters (“...”) must present in the first string.

- All characters in dumped strings are in upper case. If you see lowercase characters in dumped strings, change them to upper case.

Scanner Configuration Manager Software

Scanner Configuration Manager is a utility program designed for users to configure scanner settings on a computer by using the Microsoft Windows based operating system. Use this program to define the settings and then download the parameters to the scanner. Download the program from our web site:

<http://www.ute.com>.

The SCM is for Cradle Mode only.

SCM will be future support for MS840BT

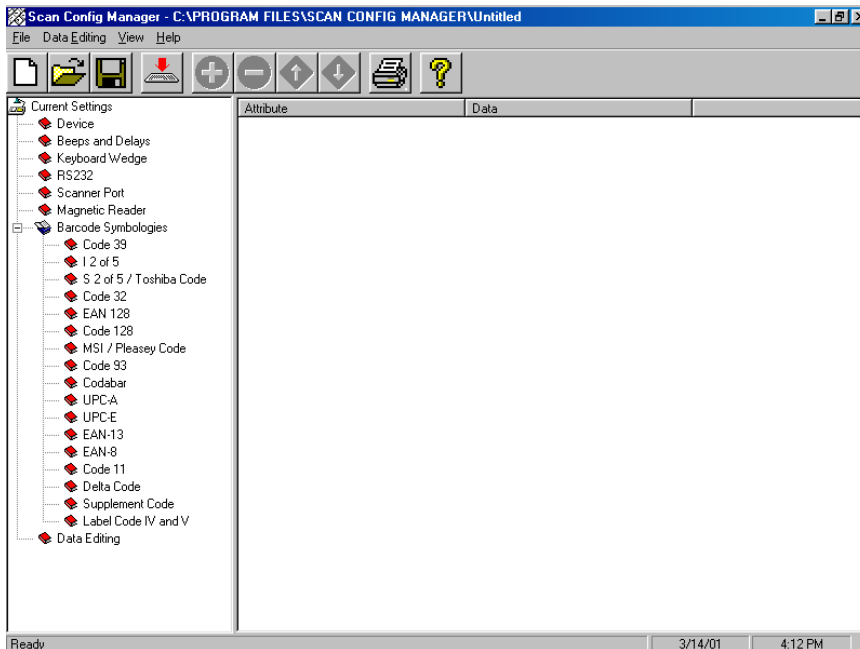

Output Data Editing

The Output Data Editing feature was removed from this barcode setup manual. It is implemented to the Scanner Configuration Manager Software providing a user-friendly interface for easier operation. Please download the latest program from Unitech's web site at <http://www.ute.com>. This chapter will mainly describe the concept and feature provided by this data output feature. The function described here also can be replaced by the "Pre-defined Labels" function. So if data-editing function is defined, "Pre-defined Labels" will be removed. They cannot be defined at the same time.

General

The purpose of Data Edit is allowing you to define and modify a data record that comes from decoding of a bar code. By using combination of formulas, you can perform the following functions on the data received by the scanner:

- A. Rearrange the output sequences.
- B. Delete characters from the record.
- C. Insert characters to the record, including function codes.
- D. Duplicate characters in the record.
- E. Insert time delay in the record

Formula

Formula is a structure that tells the scanner what and how to process the original data record to produce the desired output. The wedge allows multiple Formulas, but the number of the Formulas can be defined depends on the memory size allocated for Data Editing.

➤ Original Data Structure

The original data is the decoded data plus preamble and postamble. The original data structure is as follow:

Preamble	Decoded Data	Postamble
----------	--------------	-----------

➤ Formula Structure

A Formula consists of two parts: Qualifier and Modifier. Qualifier is used to verify if the data record meets the conditions specified and Modifier is processed only if all conditions in Qualifier are met.

➤ Execution Sequence

If several Formulas were defined, data editing will perform sequentially from the first Formula to the last Formula. If a Formula is qualified and executed, the further formulas will be ignored. If none of the Formulas is executed, the data record will be discarded and there will be no output to the host.



A-String: String to be added.
 O-String: Modified original data.
 [] : Optional.

Formula Structure

Programming

Programming Sequence

Each Formula is entered into the reader by the following sequence:

Input_ID >> Length >> Match >> A-String >> O-String >>...>> O-String >> Enter

A Formula starts with Input_ID and ends with “**Enter**”(a label in programming sheet). If a field is optional and missing, the next one in the sequence can be entered. But “**Enter**” must be the last input of a formula.

Preparation

To start the data editing, the following barcode sheets are needed:

- Programming Sheet. (Setup Sheet in Appendix D).
- Full ASCII Sheet (Appendix E).
- Function Code Sheet (Appendix B or C).

Before programming Data Editing, you should know the format of the original data record that may be altered by the setup groups.

Programming Sheet

The bold and italicized characters in following sections mean a barcode label on the Programming Sheet.

<i>Enter</i>	Scan this label to start the formula
<i>Group 10</i>	input.
<i>Group</i>	Erase all formulas.
<i>Default</i>	
<i>Review</i>	To see the formulas programmed in the Wedge. If scanning this label during a formula input (without finished by scanning " <i>Enter</i> "), the current formula will be displayed. Otherwise, all programmed formulas will be displayed.
<i>Backspace_</i>	Delete the last character.
<i>,</i>	Delimiter to separate parameters.
<i>"</i>	String specifier.
<i>*</i>	Wild character to specify any digit or any position.
<i>#</i>	Wild character to specify any letter(A--Z, a--z) or last position
<i>Enter</i>	To end the current formula.
<i>0 to 9</i>	For digit input.
<i>IN_ID</i>	For ID field input.
<i>LEN</i>	For Length field input.
<i>MATCH</i>	For Match field input.
<i>O-STR</i>	For O-String input.
<i>+</i>	For O-String input.
<i>-</i>	For O-String input.
<i>Exit</i>	Save all formulas and exit setup.

Note: The '*******', '***#***', '***"***' and '***,***' on Programming Sheet have special meanings as mentioned above and are different from those represented in Full ASCII chart. Always use characters in Full ASCII chart for string parameters unless a special function is required.

Parameter Entry

a) Digit Parameters and Numbers

Each digit parameter or number is represented by one to three digits with '***,***' as terminator. For example:

1,
023,

b) String Parameters

A string is a set of characters, wild characters, or sequence of adjacent characters enclosed in double quotation marks, which are on the Programming Sheet. For example:

"A*B# "

Here * and # are wild characters on the setup sheet.

Qualifier

There are three conditional fields in the Qualifier:
Input ID, Length and Match.

Input ID

Format:

IN_ID,ID1, ... ,IDi,

Input ID is required and the original data record must correspond to Input ID of a formula in order to be processed.

ID1 to IDi are represented by digits. The following Input IDs are available:

- 0 = Code 39 Full ASCII
- 1 = Code 39 Standard
- 2 = EAN 13
- 3 = EAN 8
- 4 = UPC A
- 5 = UPC E
- 6 = I 2 of 5
- 7 = Codabar
- 8 = Code 128
- 9 = Code 93
- 10 = S 2 of 5
- 11 = MSI

19 = All Inputs

There is no limitation on the number of IDs to be defined.

Example:

IN_ID,0,11,

What is shown above means the original data can be Code 39 or MSI.

Length

Format:

LEN,Min,Max,

Length field consists of two length parameters: minimum length (Min) and maximum length (Max). When defined, a formula will be performed if the length of the original data falls between MIN and MAX.

When missing, the following fields of current Formula are always processed.

Example:

LEN,9,48,

What is shown above means the length of original data must be within 9 and 48.

Match

Format:

MATCH, P0 , "C0" ,P1, "C1" ,...,Pn, "Cn" ,

A pair of Pn and Cn forms a Match field (n indicates a sequential integer number). To define a Match field, two parameters are required. The first is character position (Pn) and the second is a string (Cn). Character position means the number of characters, counting from the first character to the one to be positioned in the data record.

For example, in the following data

BARCODE

'B' has position 1.

'A' has position 2.

...

'E' has position 7.

When Match field is defined, the original data string starts at the position specified by the first parameter P and will be compared with string "C". If the match is identical, processing of current Formula continues.

The position parameter P could be a wild character * for any position or # for the last position in the original data. If # is used,

#-N

is valid. Here N is a digit parameter.

The string parameter C can include * for any digit or # for any letter.

Examples:

MATCH,3, "AB",#, "?" ,

Checks if the original data has 'A' at position 3, 'B' at position '4' and last character is '?'.

MATCH , 10 , " *A*",

Checks if the original data includes a string with a digit as first character and "A*" followed at position 10.

Modifier

Modifier has two types of fields: A-String and O-String to define the output contents.

A-String

Format:

"abc... "

'a', 'b' and 'c' in the string can be any character.

A-String defines a string of characters to be added to the output. For example, if the original data is:

BCD

and output string is

BarCoDe

"a", 'o' and 'e' in output string are added strings and can be defined by A-Strings.

Note: If '*' on Programming Sheet are included in A-String, one interblock delay defined by Group 2 will be inserted.

O-String

Format:

O-STR , P, N,

O-String always applies to the original data. It contains two parameters. The first is position parameter (P) that specifies the start output position in the original data. Parameter N tells how many characters will be included beginning from P.

Example:

Original data is:

Barcode

Then

O-Str , 4, 4,

Gives output as

code

Note:

- N can be '# for all remaining characters from P.
- If P greater than the length of original data, the O-String will be skipped.
- If N greater than the number of remaining characters counting from P, the remaining characters are included as valid.

Examples

Example 1

If the original data is Code 39 and content is "AA", output "ABC Company", and otherwise output the original data as it is.

IN_ID,0,LEN,2,2,MATCH,1,"AA","ABC company",Enter
IN_ID,19,O-STR,1,#,Enter

Example 2

If the original data is Code 128 and logically divided into:

- First six characters are personal ID,
- Other characters are person's name.

The output will be:

- Personal ID first,
- A 'CR' character,
- Two interblock delay,
- Name,
- A 'CR' character.

The Formula will be:

IN_ID,8,O-STR,1,6,"<CR> **",O-STR,7,#,"<CR>",Enter

<CR> is a Carriage Return character scanned from Full ASCII Chart.

Advanced Features

The O-String has the format:

O-STR,P,N,

Both parameters of **O-String** mentioned above are numbers. But both parameters can be specified as strings. If N is a string, it becomes a position and the meaning of **O-String** will be "Output from position P to position N".

If P is defined as:

"ab...ik"

a, b, l, and k can be any character, the position will be evaluated as

-- Start from the first position of the original string and search character 'a'.

-- From the position next to 'a' in original data, search for 'b'.

--

-- From the position next to 'i', search for k.

-- If above searches are all found, the result of the parameter will be the position where 'k' is located.

If N is a string, the position evaluation of N is the same as P except that the searching position is starting from P+1.

For both P and N, if string is defined, a value can be added to or subtracted from the position. That following O-Strings:

"ab...ik"+M,

and

"ab...ik"-M,

are meaningful. M is an integer number.

Example:

Suppose the following is a message to be modified:

%B012345678901234^ABEL/STEVE L MGR ^9001012999999?

In this message:

"%" is start sentinel.

"012345678901234" is account number.

"^" is a separator

6. "ABEL" is surname.

"/" is a separator.

"STEVE" is first name.

"L" is initial.

"MGR" is title

"^" is a separator.

"9001" is expiration date.

"?" is end sentinel.

The output sequence desired is:

Surname, First Name [CR] Account Number [CR] Expiration Date [CR]

























The formula input will be:

IN_ID,0,O-STR,"^"+1,"/"-1,"",O-STR,"/" +1,"<SP>"-1,"<CR>" ,O-STR,3,"^"-1,"<CR>" ,O-STR ,"^"+1,4,"<CR>" ,Enter

Here <SP> is Space character and <CR> is Carriage Return character.

The output of above input will be
ABEL,STEVE[CR]
012345678901234[CR]
9001[CR]

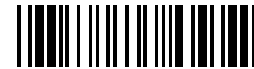
Quick Setup Sheet

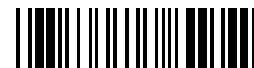
<p>Scanner Mode</p> <p> Trigger</p> <p> Flash</p>	<p>Beep</p> <p> None</p> <p> Medium</p>	<p>UPC-A</p> <p> Default</p> <p> Cut Leading Digit</p> <p> Cut Check Digit</p>
<p>UPC-E</p> <p> Default</p> <p> Cut Leading Digit</p> <p> Send Check Digit</p> <p> UPC-A Conversion</p>	<p>Terminator</p> <p> Enter</p> <p> Field Exit</p>	<p>Supplement Code</p> <p> No</p> <p> Yes</p>
<p>EAN-8</p> <p> Default</p> <p> Cut Leading Digit</p> <p> Cut Check Digit</p>	<p>Scan Code</p> <p> U.S.</p> <p> Alt Key</p>	<p>Menu Setup</p> <p> Enable / Disable</p>
<p>EAN-13</p> <p> Default</p> <p> Cut Leading Digit</p> <p> Cut Check Digit</p> <p> ISBN Conversion</p>	<p>Inter-Character Delay</p> <p> 1 ms</p> <p> 20 ms</p>	<p>Display Version</p> <p> Display Version</p> <p>Factory Default</p> <p> Factory Default</p>
	<p>Code ID</p> <p> No</p> <p> Yes</p>	

※ In cradle mode, the cradle is set for functions necessarily through SCM.

Function Codes

Function Codes for PC



F1 (%VA)



F3 (%VC)



F5 (%VE)



F7 (%VG)



F9 (%VI)



F11 (%VK)



Cursor Right (/FC)



Cursor Up (/FE)



PgUp (/FG)



TAB (/FI)



Esc (/FK)



Right Ctrl (/FO)



Shift Make (/FP)



Ctrl Make (/FQ)



Alt Make (/FR)



Del (/FX)



F2 (%VB)



F4 (%VD)



F6 (%VF)



F8 (%VH)



F10 (%VJ)



F12 (%VL)



Cursor Left (/FD)



Cursor Down (/FF)



PgDn (/FH)



Back Tab (/FJ)



Left Enter (/FL)



Right Enter (/FM)



Ins (/FW)



Shift Break (/FS)



Ctrl Break (/FT)



Alt Break (/FU)



F1 (%VA)



F2 (%VB)



F3 (%VC)



F4 (%VD)



F5 (%VE)



F6 (%VF)



F7 (%VG)



F8 (%VH)



F9 (%VI)



F10 (%VJ)



F11 (%VK)



F12 (%VL)



F13 (%VM)



F14 (%VN)



F15 (%VO)



Cursor Left (/FD)



Cursor Right (/FC)



Cursor Down (/FF)



Cursor Up (/FE)



page down (/FH)



page up (/FG)

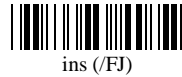

ins (/FJ)



tab (/FI)



Enter (/FL)



Esc (/FK)



return (/FM)



Option Make (%VP)



Option Break (%VQ)



Control Make (%VR)



Control Break (%VS)



Shift Make (%VT)



Shift Break (%VU)



Apple Make (%VV)



Apple Break (%VW)

Function Codes for IBM Terminals

F1 (%VA)

F3 (%VC)

F5 (%VE)

F7 (%VG)

F9 (%VI)

F11 (%VK)

F13 (%VM)

F15 (%VO)

F17 (%VQ)

F19 (%VS)

F21 (%VU)

F23 (%VW)

Home (/FA)

TAB (/FI)

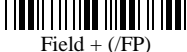
Return (/FM)

Field + (/FP)

Clear(/FR)

F2 (%VB)

F4 (%VD)

F6 (%VF)

F8 (%VH)

F10 (%VJ)

F12 (%VL)

F14 (%VN)

F16 (%VP)

F18 (%VR)

F20 (%VT)

F22 (%VV)

F24 (%VX)

End (/FB)

Enter (/FL)

Field Exit (/FO)

Field - (/FQ)

Reset (/FV)

Setup Menu

D.1 Beeps and Delays



Enter Group 2



Group Default

 0	Beep Tone: 0 -- None 1 -- Low <u>2 -- Medium</u> 3 -- High 4 -- Low to High 5 -- High to Low	 A1
 1	Interblock Delay: <u>0 -- 0 ms</u> 1 -- 10 ms 2 -- 50 ms 3 -- 100 ms 4 -- 500 ms 5 -- 1 seconds 6 -- 3 seconds 7 -- 5 seconds	 A2
 2	Intercharacter Delay: <u>0 -- 0 ms</u> 1 -- 1 ms 2 -- 2 ms 3 -- 5 ms 4 -- 10 ms 5 -- 30 ms 6 -- 50 ms 7 -- 100 ms	 A3
 3	Power Saving Mode: <u>0 -- 10 minutes</u> 1 -- 30 minutes 2 -- 60 minutes 3 -- 240 minutes	 A4
 4	PharmaCode (Ease on decoding) <u>0 -- Disable</u> 1 -- Enable	 A5
 5	Reserve	 A6
 6		 Exit

D.2 Keyboard Wedge Settings



Enter Group 3



Group Default



0

Function Code:

0 -- Off

1 -- ON



B1



1

Caps-Lock:

0 – Auto Trace(PC/XT,AT)

1 – Lower Case

2 – Upper Case



B2



2

Language (For PC/XT/AT):

- 0-U.S.** 5-Norwegian :-Danish
- 1-U.K. 6-Italian ;-Partial Alt
- 2-Swiss 7-German <-Japanese
- 3-Swedish 8-French
- 4-Spanish 9-Alt Key Mode



B3



3

Output of Wand Emulation:

0—Bar with High/Space with Low

1—Bar with Low/Space with High



B4



4

Level Duration of Mini Width:

0—200us

1—600us



B5



5

Polarity of Idle Condition:

0—Low

1—High



B6



6

Pre-define Label:

0—Label 0 1—Label 1 2—Label 2
(See “Pre-defined label” section for detail)



B7



7

Use number keypad digits:

0—Disable 1—Enable



B8



8



9



Exit

D.3 RS232 Settings



Enter Group 4



Group Default



0

Baud Rate:

- 0 -- 300 4 -- 4800
- 1 -- 600 **5 -- 9600**
- 2 -- 1200 6 -- 19200
- 3 -- 2400 7 -- 38400



C1



1

Parity:

- 0 – Even 3 -- Space
- 1 – Odd **4 -- None**
- 2 – Mark



C2



2

Data Bit:

- 0 – 7
- 1 – 8**



C3



3

Handshaking (for serial wedge):

- 0 – Ignore** 1 – RTS Enabled in Communication
- 2 – RTS Enable at Power up
- 3 / 4 – Special Bell Off / On**



C4



4

ACK/NAK (for serial wedge):

- 0 – Off**
- 1 – On



C5



5

BCC Character (for serial wedge):

- 0 – Off**
- 1 – On



C6



6

Time Out (for serial wedge):

- 0 -- 1 sec**
- 1 – 3 sec
- 2 – 10sec
- 3 – Unlimited



C7



7

Data Direction (for Terminal Wedge):

- 0 – Send to Host**
- 1 – Send to Host and Terminal
- 2 – Send to Terminal



C8

Define Terminator of RS232 input:

Scan an ASCII code in full ASCII Chart to select a new RS232 Terminator.



C9



Exit

D.4 Scanner Port



Enter Group 5



Group Default



0

Terminator:

0—Enter

- 1--Return (on digits keypad)
- 2--Field Exit or Right Ctrl
- 3--None



D1



1

Code ID: 0 – disable

- 1 – Enable



D2



2

Note: This setting doesn't affect EAN128 Code ID.
EAN128 has its own Code ID setting on page D.7.

Define Code ID:

- | | |
|-----------------------|---------------------------------------|
| 00—Code 39 Full ASCII | 0 - Standard 2 of 5 |
| 01—Code 39 Standard | 1 - MSI Code |
| 02—EAN-13 | 2 - EAN128 |
| 03—UPC-A | 3 - Code32 (Italian pharmacy) |
| 04—EAN-8 | 4 - Delta Code |
| 05—UPC-E | 5 - Label Code |
| 06—Interleaved 2 of 5 | 6 - Plessey Code |
| 07—Codabar | 7 - Code 11(Special) |
| 08—Code 128 | 18 - China Postal code (Toshiba Code) |
| 09—Code 93 | |



D3

Scan two digits to choose a code, and then scan a char. From full ASCII table to define ID.



3



4



5

Double Verification:

0 – Off

- 1~7 – On(Verify 1~7 times)



D4



6

Scanning Mode & Trigger Function:

- | | | |
|---|----------------|---------------|
| <u>0 – Trigger</u> | 1 – Flashing | 2 – Multiscan |
| 3 – One Press One Scan | 4 – Test Mode | |
| 5 – Old Laser flash Mode | 6 – Continuous | |
| 7 – Trigger with Command control scanning | | |



D5

Trigger in Flash: 8 -Enabled -, 9- Disabled



8

Label Type:

0 – Positive

- 1 – Positive and Negative



D6



9

Aim function for long range laser engine:

0—Disable

- 1—Enable
- Aiming Time: 2—0.5s, 3—1s, 4—1.5s, 5—2s



D7

Data Length (Two Digits) Send:

0—Disable

- 1—Enable



D8

Preamble



PP

Postamble



OO

Scan 'PP\OO' for Pre\Postamble. Scan characters from Full ASCII char or Function



Exit

D.5 Operating Modes



Enter Group 6



Group Default



0

Buffer Mode

- 0— Disabled
- 1— Inventory Mode



E1



1

2 — Batch Mode

Reserve



E2



2

Buffer Transmit delay

- | | | |
|---------------|----------|----------|
| 0—50ms | 1— 100ms | 2— 300ms |
| 3— 600ms | 4— 1s | 5— 2s |
| 6— 3s | 7— 5s | |



E3



3

Reserve



4

Reserve



5

Reserve



6

Reserve



7

Reserve



8

Reserve



9



Exit

D.6 Code 39 / I 2 of 5 / S 2 of 5 / Code 32 / EAN128



Enter Group 7



Group Default



0

Code 39:

0/1--Disable/**Enable**.
2/3--Full ASCII/ Standard.
 4--Check Digit (CD) Calculate & Send.
 5--CD Calculate, not send.
6 --CD not Calculate.
 7/8 -- Send/**No Send** Start/Stop
 9/: -- Double labels decoding **Off/On**
 0 - 48 -- Min length **0** / Max length **48**



F1



1



2

I 2 of 5 (ITF):

0/1--Disable/**Enable**
 2/3--Fix Length **On/Off** (by first three reads)
 4--Check Digit (CD) Calculate & Send
 5--CD Calculate, not send.
6—CD not Calculate
 7--First Digit Suppressed.
 8--Last Digit Suppressed
9 -- Not Suppressed
 2 - 64 -- Min length **10** / Max length **64**



F2



3



4



5

S 2 of 5 / China Postal Code (Toshiba Code):

0/1--**Disable/Enable**
 2/3 -- Fix Length **On/Off** (by first three reads)
 4--Check Digit (CD) Calculate & Send
 5--CD Calculate, not send. **6--CD not Calculate**
 1 - 48 -- Min length **4** / Max length **48**



F3



6



7

Code 32(Italian pharmacy):

0/1 -- **Disable/Enable**
 2/3 -- Leading Character **Send** / No Send
 4/5 -- Tailing Character **Send** / No Send



F4



8

Telepen:

0/1 – **Disable/Enable** 2/3 – **Standard**/Numeric Set



F5



9

UCC/EAN 128:

0/1—**Disable/Enable**
 2/3—**Code ID Disable/Enable**
 Note: If EAN128 be disabled, the EAN128 labels will be decoded as Code 128



F6

Define the EAN128 Fields separator:

Scan a ASCII code in full ASCII code chart to select a new Fields Separator



F7

Define a separator for double labels:

Scan a ASCII code in full ASCII code chart to select a new definition of Func1



F8

Min Length



MM

Max Length



NN



Exit

D.7 Code 128 / MSI Code / Code 93 / Codabar/ Label Code



Enter Group 8



Group Default



0

Code 128:

0/1 -- Disable/**Enable**
1-64 -- Min Length 1 / Max Length **64**



G1



1

MSI /Plessey Code:

0/1 -- **Disable**/Enable
2/3 -- Check Digit Send / **No Send**
4 -- Check Digit Double Module 10
5 -- Check Digit Module 11 plus 10
6 -- Check Digit Single Module 10
1-16 -- Min Length 1 / Max Length **16**



G2



2

Code 93:

0/1 -- Disable/**Enable**
1-48 -- Min Length 1 / Max Length **48**



G3



3

Code 11: (Special)

0/1 -- **Disable**/Enable
2/3 -- One / **Two** Check Digit
4/5 -- Check Send / **No Send**
1-48 -- Min Length 1 / Max Length **48**



G4



4

Codabar:

0/1 -- **Disable**/Enable
2/3 -- Start & Stop Send / **No Send**
4 -- Check Digit Calculate & Send
5 -- Check Digit Calculate but not Send
6 -- Check Digit not Calculate
7/8 -- CLSI Format On / **Off**
3-48 -- Min Length 3 / Max Length **48**



G5



5



6

Label Code IV and V:

0/1 -- **Disable**/Enable
2/3 -- **Checksum send**/ No send



G6



7

Min Length



MM



8

Max Length



NN



9



Exit

D.8 UPC / EAN / Delta Code



Enter Group 9



Group Default



0

UPC-A:

- 0/1 -- Disable/**Enable**
- 2/3 -- Leading Digit **Send** / No Send
- 4/5 -- Check Digit **Send** / No Send



H1



1

UPC-E:

- 0/1 -- Disable/**Enable**
- 2/3 -- Leading Digit **Send** / No Send
- 4/5 -- Check Digit **Send** / **No Send**
- 6/7 -- Zero Expansion On / **Off**
- 8/9 -- **Disable**/Enable NSC=1



H2



2

EAN-13:

- 0/1 -- Disable/**Enable**
- 2/3 -- Leading Digit **Send** / No Send
- 4/5 -- Check Digit **Send** / No Send
- 6/7 -- ISBN Enable / **Disable**



H3



4

EAN-8:

- 0/1 -- Disable/**Enable**
- 2/3 -- Leading Digit **Send** / No Send
- 4/5 -- Check Digit **Send** / No Send



H4



5

Supplement Code:

- 0/1 -- Two Supplement Code **Off** / On
- 2/3 -- Five Supplement Code **Off** / On
- 4 -- Transmitted if Present
- 5 -- Must Present.**
- 6/7 -- Space Separator Inserted / **Not Inserted**



H5



6

Delta Distance Code:

- 0/1 -- **Disable**/Enable
- 2/3 -- Check Digit **Calculated** / Not Calculated
- 4/5 -- **Check Digit Send** / No Send



H6



7

Reserved:



H7



9

RSS14 Code:

- 0/1 RSS14 Disable / **Enable**
- 2/3 RSS Expanded Disable / **Enable**
- 4/5 RSS Limited **Disable** / Enable
- 6/7 Linkage Digit **Not Send** / Send
- 8/9 Use UCC/EAN128 ID **Off**/On



H8



Exit

D.9 Dump Setup Strings

See the section *Batch Setup* for how to use the labels below.



Dump Settings



Dump Settings on PC/AT

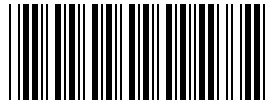

PC/AT Interface Keyboard setting

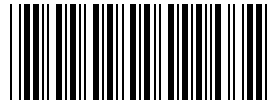

RS232 Interface Keyboard Setting

(Speed=9600,Databit=8,Parity = None, Stop=1 Flow Control = None)

Full ASCII Chart

Characters in parentheses represent Code 39 barcode printing



NUL (%U)



LF (\$J)



DC4 (\$T)



SOH (\$A)



VT (\$K)



NAK (\$U)



STX (\$B)



FF (\$L)



SYN (\$V)



ETX (\$C)



CR (\$M)



ETB (\$W)



EOT (\$D)



SO (\$N)



CAN (\$X)



ENQ (\$E)



SI (\$O)



EM (\$Y)



ACK (\$F)



DLE (\$P)



SUB (\$Z)



BEL (\$G)



DC1 (\$Q)



ESC (%A)



BS (\$H)



DC2 (\$R)



FS (%B)



HT (\$I)



DC3 (\$S)



GS (%C)

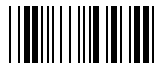

RS (%D)



US (%E)



SP



! (/A)



" (/B)



(/C)



\$



%



& (/F)



' (/G)



((/H)



) (/I)



* (/J)



+



, (/L)



-



.



/



0



1



2



3



4



5



6



7



8



9



: (/Z)



; (%F)



< (%G)



= (%H)



> (%I)



? (%J)



J



U



@ (%V)



K



V



A



L



W



B



M



X



C



N



Y



D



O



Z



[(%K)



P



[(%K)



E



Q



\ (%L)



F



R



] (%M)



H



S



^ (%N)



I



T



_ (%O)



\ (%W)



a (+A)



b (+B)



c (+C)



d (+D)



e (+E)



f (+F)



g (+G)



h (+H)



i (+I)



j (+J)



k (+K)



l (+L)



m (+M)



n (+N)



o (+O)



p (+P)



q (+Q)



r (+R)



s (+S)



t (+T)



u (+U)



v (+V)



w (+W)



x (+X)



y (+Y)



z (+Z)



{ (%P)



| (%Q)



} (%R)



~ (%S)



DEL (%T)

Appendix E

Barcode Test Chart

EAN-13



EAN-8



UPC-A



UPC-E



ISBN 957-630-239-0



Interleaved 2 of 5



Code 39

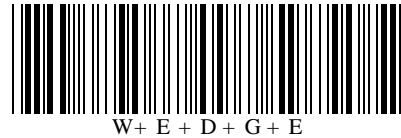

Code 39 with C/D



EAN 128



Code 128



Codabar



MSI Code



Appendix F

Worldwide Support

Unitech's professional support team is available to quickly answer questions or technical-related issues. Should a set of equipment problem occurs, please contact the nearest Unitech regional service representative. For complete contact information please visit the Web sites listed below:

Region	Web Site
Global Operation Center	http://www.ute.com
Unitech Taiwan	http://tw.ute.com
Unitech Asia Pacific & Middle East	http://apac.ute.com ; http://india.ute.com
Greater China Division	http://cn.ute.com
Unitech Japan	http://jp.ute.com
Unitech America	http://us.ute.com ; http://can.ute.com
Unitech Latin America	http://latin.ute.com
Unitech Europe	http://eu.ute.com